

Mod. STF/12

cal. 12/76 - 12/3"

SHORT VERSIONS

COMPLETE = A-133-A-ST

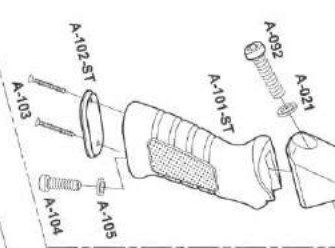

SPARE BARRELS:
 (28mm - 41") 927.220.078
 (30mm - 41") 927.220.089
 (30mm - 48") 927.220.098
 (30mm - 50") 927.220.097
 (30mm - 52") 927.220.077

PISTOL GRIP VERSIONS

COMPLETE = A-135-A-ST

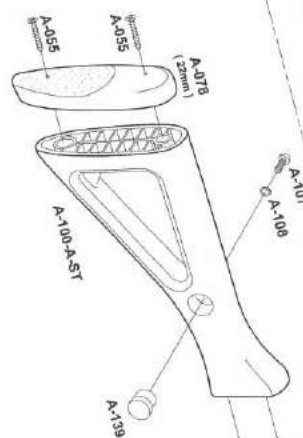

COMPACT VERSIONS

COMPLETE = A-143-A-ST

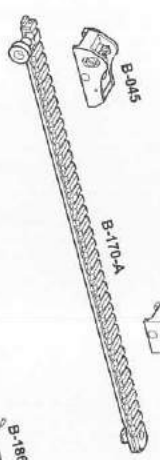
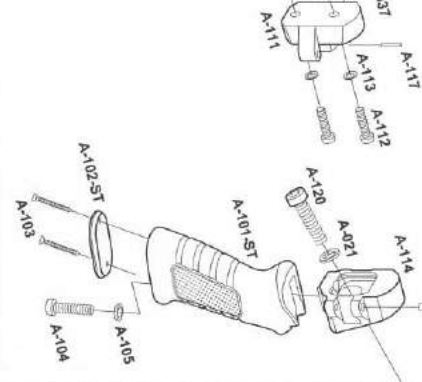
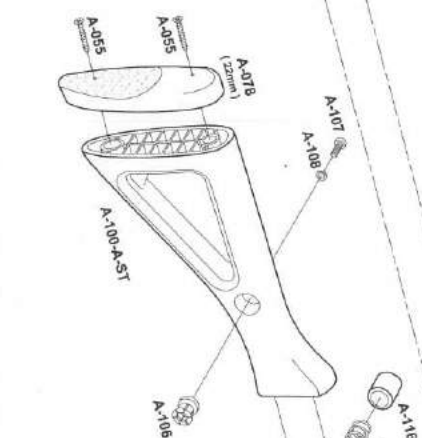

OPTIONAL

A-053 (28mm)
 A-075 (27mm)

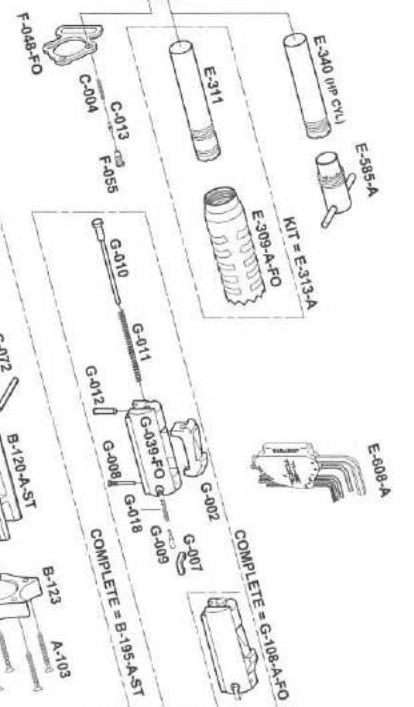
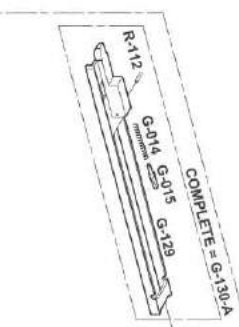
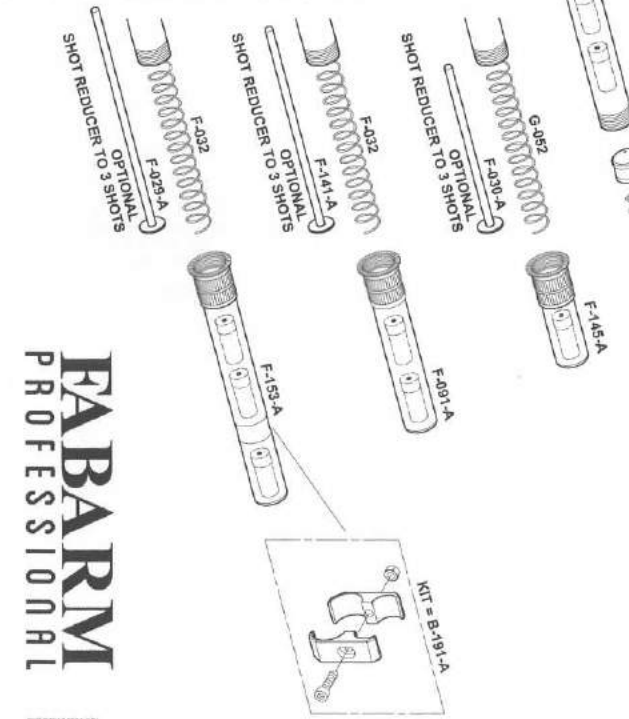
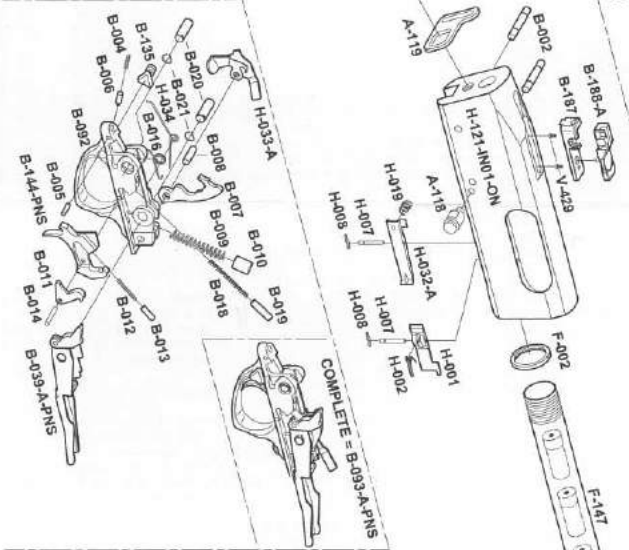
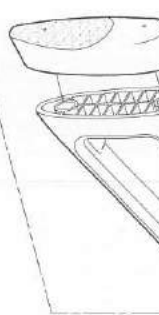

Parti ricambio STF/12		Spare parts for STF/12		Pièces détachées pour STF/12	
CODICE	DESCRIZIONE	CODE	DESCRIPTION	CODE	DESCRIPTION
A-021	RONDELLA VITE FISSAGGIO SUPPORTO FISSO	A-021	WASHER FOR FIXED SUPPORT SCREW	A-021	RONDELLE DE VIS DU BLOC FIXE DE CHARNIERE
A-027	MOLLA PER CALCIO PIEGHEVOLE	A-027	FOLDING STOCK SPRING	A-027	RESSORT DE CROSSE RABATTABILE
A-055	VITI PER CALCIO (n° 2)	A-055	RECUL PAD SCREWS (n° 2)	A-055	VIS DE SABOT ANTI-RECUL (n° 2)
A-078	CALCIOLO IN GOMMA HRA 27mm	A-078	HRA RUBBER RECUL PAD 27mm	A-078	SABOT ANTI-RECUL CAOUTCHOUC HRA 27mm
A-092	TIRANTE PER IMPUGNATURA A PISTOLA	A-092	CONNECTING ROD FOR PISTOL GRIP	A-092	VIS DE FIXATION DE POIGNEE PISTOLET
A-100-A-ST	TELAIO CALCIO PIEGHEVOLE	A-100-A-ST	FOLDING STOCK FRAME	A-100-A-ST	CROSSE RABATTABILE
A-101-ST	IMPUGNATURA A PISTOLA	A-101-ST	PISTOL GRIP	A-101-ST	POIGNEE PISTOLET
A-102-ST	TAPPO PER IMPUGNATURA	A-102-ST	PISTOL GRIP COVER	A-102-ST	CALOTTE DE POIGNEE
A-103	VITE AUTOFILETTANTE (n° 5)	A-103	SCREW (n° 5)	A-103	VIS DE FIXATION DE LA CALOTTE DE POIGNEE (n° 5)
A-104	VITE IMPUGNATURA	A-104	PISTOL GRIP SCREW	A-104	VIS DE FIXATION DE LA POIGNEE
A-105	RONDELLA PER TIRANTE IMPUGNATURA	A-105	BOLT CAP PISTOL GRIP	A-105	RONDELLE DE VIS DE FIXATION DE POIGNEE PISTOLET
A-106	BUSSOLA AGGANCIAMENTO CALCIO PIEGHEVOLE	A-106	FOLDING STOCK RETAINING INSERT	A-106	CLIVE DE VERROUILLAGE DE CROSSE
A-107	VITE FISSAGGIO BUSSOLA CALCIO	A-107	FOLDING STOCK RETAINING INSERT SCREW	A-107	VIS DE FIXATION DE L'CLIVE
A-108	RONDELLA PER VITE BUSSOLA CALCIO	A-108	FOLDING STOCK RETAINING INSERT SCREW WASHER	A-108	RONDELLE DE VIS DE FIXATION DE L'CLIVE
A-111	SUPPORTO MOBILE CALCIO PIEGHEVOLE	A-111	MOBILE SUPPORT FOR FOLDING STOCK	A-111	SUPPORT MOBILE DE CROSSE RABATTABILE
A-112	VITE FISSAGGIO SUPPORTO (n° 2)	A-112	SUPPORT SCREW (n° 2)	A-112	VIS DE FIXATION DE L'INSERT DE CROSSE (n° 2)
A-113	RONDELLA PER VITE SUPPORTO (n° 2)	A-113	SUPPORT SCREW WASHER (n° 2)	A-113	RONDELLE DE VIS DE FIXATION DE L'INSERT (n° 2)
A-114	SUPPORTO FISSO CALCIO PIEGHEVOLE	A-114	FIXED SUPPORT FOR FOLDING STOCK	A-114	SUPPORT FIXE DE CROSSE RABATTABILE
A-115	PERNO ROTAZIONE CALCIO	A-115	PIVOT PIN FOR FOLDING STOCK	A-115	AXE DE CHARNIERE POUR CROSSE RABATTABILE
A-116	PULSANTE SGANCIO CALCO PIEGHEVOLE	A-116	LOOKING BUTTON	A-116	BOUCHON POUSSOIR DE VERROUILLAGE DE CROSSE
A-117	SPINA FERMO PULSANTE SGANCIO	A-117	LOOKING BUTTON PIN	A-117	AXE DE FIXATION DU POUSSOIR
A-118	PERNO AGGANCIAMENTO CALCO PIEGHEVOLE	A-118	FOLDING STOCK RETAINING PIN	A-118	AXE DE FIXATION DE CROSSE EN POSITION FERMEE
A-119	PIASTRINA LATERALE PORTACANNA POSTERIORE	A-119	REAR SIDE SWIVEL PLATE	A-119	PLAQUE ARRIERE LATERALE POUR GRENADEIERS
A-120	VITE FISSAGGIO SUPPORTO FISSO	A-120	FIXED SUPPORT SCREW	A-120	VIS DE FIXATION DU SUPPORT FIXE DE CHARNIERE
A-131	PIASTRA PORTACANNA 1 POSIZIONE POSTERIORE	A-131	REAR ONE POSITION SWIVEL PLATE	A-131	PLAQUE ARRIERE POUR GRENADEIERS 1 POSITION
A-132	SUPPORTO ATTACCO IMPUGNATURA	A-132	FIXED SUPPORT FOR GRIP	A-132	BLOC SUPPORT DE POIGNEE
A-133-A-ST	IMPUGNATURA COMPLETA	A-133-A-ST	COMPLETE GRIP	A-133-A-ST	POIGNEE COMPLETE
A-135-A-ST	CALCO FISSO COMPLETO	A-135-A-ST	COMPLETE FIXED STOCK	A-135-A-ST	CROSSE FIXE COMPLETE
A-136	SUPPORTO POSTERIORE CALCIO FISSO	A-136	REAR FIXED STOCK SUPPORT	A-136	SUPPORT ARRIERE DE CROSSE FIXE
A-137	SUPPORTO ANTERIORE CALCIO FISSO	A-137	FRONT FIXED STOCK SUPPORT	A-137	SUPPORT AVANT DE CROSSE FIXE
A-138	SPINA FISSAGGIO SUPPORTI CALCIO (n° 2)	A-138	STOCK SUPPORTS PIN (n° 2)	A-138	GOUILLE POUR SUPPORTS DE CROSSE FIXE (n° 2)
A-139	TAPPO CALCIO FISSO	A-139	FIXED STOCK COVER CAP	A-139	BOUCHON SUR CROSSE FIXE
A-141	VITE CARCASSA CON CALCIO FISSO	A-141	SCREW FOR FRAME WITH FIXED STOCK	A-141	VIS POUR CARCASSA AVEC CROSSE FIXE
A-143-A-ST	CALCO PIEGHEVOLE COMPLETO	A-143-A-ST	FOLDING STOCK COMPLETE	A-143-A-ST	CROSSE RABATTABILE COMPLETE
B-002	SPINA FISSAGGIO SOTTOGUARDIA (n° 2)	B-002	TRIGGER GUARD RETAINING PIN (n° 2)	B-002	GOUILLE DU PONTET (n° 2)
B-004	MOLLA PER BOTTONE SICURA	B-004	HAND SAFETY SPRING	B-004	RESSORT DE LA SURETE
B-005	SPINA ARRESTO MOLLA SICURA	B-005	HAND SAFETY SPRING PIN	B-005	GOUILLE DE RESSORT DE LA SURETE
B-006	GUIDAMOLLA PER SICURA	B-006	HAND SAFETY SPRING PLUNGER	B-006	TIGE RESSORT DE SURETE
B-007	CANE	B-007	HAMMER	B-007	CHIEN
B-008	PERNO DEL CANE	B-008	HAMMER PIN	B-008	AXE DU CHIEN
B-009	MOLLA DEL CANE	B-009	HAMMER SPRING	B-009	RESSORT DE CHIEN
B-010	CALOTTA PER MOLLA CANE	B-010	HAMMER SPRING FOLLOWER	B-010	DOUILLE RESSORT CHIEN
B-011	DENTE AGGANCIAMENTO CANE	B-011	SEAR	B-011	GACHETTE
B-012	MOLLA DENTE AGGANCIAMENTO CANE	B-012	SEAR SPRING	B-012	RESSORT DE GACHETTE
B-013	GUIDAMOLLA DENTE AGGANCIAMENTO CANE	B-013	SEAR SPRING FOLLOWER	B-013	DOUILLE RESSORT DE GACHETTE
B-014	PERNO GRILLETTO E DENTE AGGANCIAMENTO CANE	B-014	TRIGGER AND SEAR PIN	B-014	AXE DE DETENTE ET DE GACHETTE
B-016	MOLLA RICHIAMO GRILLETTO	B-016	TRIGGER SPRING	B-016	RESSORT DE DETENTE
B-018	MOLLA RICHIAMO ELEVATORE	B-018	CARRIER SPRING	B-018	RESSORT DE L'ELEVATEUR
B-019	GUIDAMOLLA RICHIAMO ELEVATORE	B-019	CARRIER SPRING GUIDE	B-019	TIGE DE RESSORT DE L'ELEVATEUR
B-020	BUSSOLA SOTTOGUARDIA (n° 2)	B-020	TRIGGER GUARD PIN BUSHING (n° 2)	B-020	DOUILLE DU PONTET (n° 2)
B-021	MOLLA PER BUSSOLA SOTTOGUARDIA (n° 2)	B-021	TRIGGER GUARD PIN SPRING (n° 2)	B-021	RESSORT DE DOUILLE DU PONTET (n° 2)
B-039-A-PNS	ELEVATORE COMPLETO	B-039-A-PNS	COMPLETE CARRIER	B-039-A-PNS	ELEVATEUR COMPLET
B-045	MIRA POSTERIORE REGOLABILE	B-045	ADJUST SIGHT	B-045	DIOPTR
B-092	SOTTOGUARDIA	B-092	TRIGGER GUARD	B-092	PONTET
B-093-A-PNS	SOTTOGUARDIA COMPLETO	B-093-A-PNS	TRIGGER GUARD COMPLETE	B-093-A-PNS	SOUS-GARDE COMPLETE
B-120-A-ST	ASTA	B-120-A-ST	FOREND	B-120-A-ST	GARDE-MAIN
B-121	BASE PICATINNY PER ASTA	B-121	FOREND PICATINNY RAIL	B-121	RAIL PICATINNY POUR GARDE-MAIN
B-122	SPINA FERMO PICATINNY ASTA	B-122	FOREND PICATINNY RAIL PIN	B-122	INSERT DE RENFORT POUR RAIL
B-123	TAPPO ANTERIORE ASTA	B-123	FOREND FRONT CAP	B-123	INSERT AVANT DE GARDE-MAIN
B-124	TAPPO POSTERIORE ASTA	B-124	FOREND REAR CAP	B-124	INSERT ARRIERE DE GARDE-MAIN
B-135	BOTTONE SICURA MANUALE	B-135	HAND SAFETY BUTTON	B-135	POUSSOIR DE SURETE
B-144-PNS	GRILLETTO	B-144-PNS	TRIGGER	B-144-PNS	DETENTE
B-145	VITE FISSAGGIO BASE PICATINNY ASTA	B-145	FOREND PICATINNY RAIL SCREW	B-145	VIS POUR RAIL
B-170-A	SLITTA PICATINNY AMMOVIBILE A PIVOT COMPLETA	B-170-A	COMPLETE PICATINNY RAIL WITH PIVOT SYSTEM	B-170-A	RAIL PICATINNY A PIVOT COMPLET
B-178-A	MIRINO ANTERIORE AMMOVIBILE	B-178-A	REMOVABLE FRONT SIGHT	B-178-A	GUIDON AMOVIBLE
B-180	VITE TIRAGGIO SLITTA	B-180	TIGHTENING PIVOT BASE SCREW	B-180	VIS DE SERIAGES POUR BASE PIVOT
B-182	MIRINO ANTERIORE REGOLABILE	B-182	ADJUSTABLE FRONT SIGHT	B-182	GUIDON REGULABLE
B-183	SUPPORTO ANTERIORE COPRICANNA	B-183	FRONT COOLING JACKET SUPPORT	B-183	SUPPORT AVANT DE CHEMISE DE CANON
B-184	SUPPORTO POSTERIORE COPRICANNA	B-184	REAR COOLING JACKET SUPPORT	B-184	SUPPORT ARRIERE DE CHEMISE DE CANON
B-185	COPRICANNA	B-185	COOLING JACKET	B-185	CHEMISE DE CANON
B-186	VITE FISSAGGIO COPRICANNA (n° 4)	B-186	COOLING JACKET SCREWS (n° 4)	B-186	VIS DE CHEMISE DE CANON (n° 4)
B-187	BASE MIRA CARCASSA	B-187	PICATINNY RAIL LOCKING BASIS	B-187	BASE DE VERROU DE RAIL PICATINNY
B-188-A	COPRIFRANTO MIRA CARCASSA COMPLETO	B-188-A	REAR SIGHT COVER	B-188-A	CACHE DE HAUSSE
B-191-A	KIT DISTANZIALE CANNA / TUBO PROLUNGA	B-191-A	BARREL / MAGAZINE SPACER KIT	B-191-A	INTERFACE COMPLET CANON / TUBE MAGASIN
B-193	TASSELLO PARAMANO	B-193	STOPPING BLOCK	B-193	BLOC D'ARRET
B-194	VITE FISSAGGIO PARAMANO	B-194	STOPPING BLOCK SCREW	B-194	VIS DE BLOC D'ARRET
B-195-A-ST	ASTA COMPLETA	B-195-A-ST	FOREND COMPLETE WITH ACTION BAR	B-195-A-ST	GRUPPE BLOC-MAIN AVEC BRAS DE COMMANDE
B-197-A	KIT BASE PICATINNY PER ASTA	B-197-A	FOREND PICATINNY RAIL KIT	B-197-A	KIT RAIL DE GARDE-MAIN
C-004	MOLLA PIVOTO TAPPO SERBATOIO	C-004	RETAINING PIN SPRING	C-004	RESSORT ERGOT ANTI-RETOUR
C-013	PIOLO BLOCCA TAPPO SERBATOIO	C-013	FOREND GAP RETAINING PIN	C-013	ERGOT ANTI-RETOUR
C-072	SPINA FISSAGGIO CARRELLO	C-072	LOCKING SLIDE PIN	C-072	GOUILLE DE FIXATION DU BRAS DE COMMANDE
E-004	ESPULSORIO MOBILE	E-004	MOBILE EJECTOR LEVER	E-004	EJECTEUR
E-005	MOLLA ESPULSORIO MOBILE	E-005	EJECTOR LEVER SPRING	E-005	RESSORT D'EJECTEUR
E-006	SPINA ESPULSORIO MOBILE	E-006	EJECTOR LEVER RETAINING PIN	E-006	AXE D'EJECTEUR
E-009	GUIDAMOLLA ESPULSORIO MOBILE	E-009	EJECTOR LEVER SPRING FOLLOWER	E-009	TIGE GUIDE DE RESSORT D'EJECTEUR
E-309-A-FO	SPERGIAMMA	E-309-A-FO	MUZZLE BREAK	E-309-A-FO	FREIN DE BOUCHE
E-311	STROZZATORE HP CYL CON ATTACCO SPERGIAMMA	E-311	SPECIFIC CHOKE FOR DOOR BREACHER	E-311	CHOKE SPECIFIQUE POUR FREIN DE BOUCHE
E-313-A	KIT SPERGIAMMA COMPLETO	E-313-A	COMPLETE DOOR BREACHER KIT	E-313-A	FREIN DE BOUCHE COMPLET
E-340	STROZZATORE HP CYL	E-340	INNER HP CYL CHOKER TUBE	E-340	CI OKE INNER HP CYL
E-385-A	CHIAVE STROZZATORI	E-385-A	CHOKER TUBE WRENCH	E-385-A	CLIF POUR CHOKE
E-608-A	KIT CHIAVI ESAGONALI	E-608-A	HEXAGONAL KEY KIT	E-608-A	KIT CLIFES HEXAGONALES
F-002	GHERSA TUBO SERBATOIO	F-002	MAGAZINE TUBE WASHER	F-002	CONTRE ECROU ANTI-ROTATION DU TUBE MAGASIN
F-003	CALOTTA SPINGI CARTUCCIA	F-003	MAGAZINE FOLLOWER	F-003	CALOTTE DE MAGASIN
F-027-BT	TAPPO TUBO SERBATOIO	F-027-BT	MAGAZINE CAP	F-027-BT	BOUCHON DE MAGASIN
F-032	MOLLA TUBO SERBATOIO	F-032	MAGAZINE SPRING	F-032	RESSORT DE TUBE MAGASIN
F-038	ANELLO TENUTA MOLLA SERBATOIO	F-038	MAGAZINE SPRING RETAINING RING	F-038	CLIP FIXATION RESSORT DANS TUBE MAGASIN
F-048-FO	PIASTRINA PORTACANNA ANTERIORE	F-048-FO	BARREL FRONT SWIVEL PLATE	F-048-FO	PLAQUE ANTERIEURE POUR GRENADEIERS
F-056	CONTENITORE PIVOTO BLOCCA TAPPO SERBATOIO	F-056	FOREND CAP RETAINING PIN	F-056	ERGOT ANTI-RETOUR DE BOUCHON MAGASIN
F-091-A	PROLUNGA + 2 COLPI	F-091-A	MAGAZINE EXTENSION + 2 ROUNDS	F-091-A	PROLONGE DE TUBE MAGASIN + 2 CARTOUCHES
F-145-A	PROLUNGA + 1 COLPO	F-145-A	MAGAZINE EXTENSION + 1 ROUND	F-145-A	PROLONGE DE TUBE MAGASIN + 1 CARTOUCHE
F-147	TUBO SERBATOIO	F-147	MAGAZINE TUBE	F-147	TUBE MAGASIN
F-153-A	PROLUNGA + 3 COLPI	F-153-A	MAGAZINE EXTENSION + 3 ROUNDS	F-153-A	PROLONGE DE TUBE MAGASIN + 3 CARTOUCHES
G-002	RAVPORE	G-002	LOCKING BOLT	G-002	VERROU
G-007	ESTRATTORE	G-007	EXTRACTOR	G-007	EXTRACTEUR
G-008	PERNO ESTRATTORE	G-008	EXTRACTOR RETAINING PIN	G-008	GOUILLE DE L'EXTRACTEUR
G-009	GUIDAMOLLA ESTRATTORE	G-009	EXTRACTOR PLUNGER	G-009	TIGE DU RESSORT DE L'EXTRACTEUR
G-010	PERCUSSORE	G-010	FIRING PIN	G-010	PERCUTEUR
G-011	MOLLA PERCUSSORE	G-011	FIRING PIN SPRING	G-011	RESSORT DU PERCUTEUR
G-012	PERNO CORSA PERCUSSORE	G-012	FIRING PIN STOP	G-012	GOUILLE DE RETENUE DU PERCUTEUR
G-014	MOLLA RICHIAMO CARRELLO	G-014	BOLT SLIDE SPRING	G-014	RESSORT DE TAPPEL
G-015	GUIDAMOLLA RICHIAMO OTTURATORE	G-015	BOLT SLIDE SPRING GUIDE	G-015	RAPPEL DE POSITION CLASSE
G-018	MOLLA ESTRATTORE	G-018	EXTRACTOR SPRING	G-018	RESSORT DE L'EXTRACTEUR
G-030-FO	OTTURATORE	G-030-FO	BREACH BOLT	G-030-FO	BLOC DE CLASSE
G-052	MOLLA TUBO SERRATOIO	G-052	MAGAZINE SPRING	G-052	RESSORT DE MAGASIN
G-108-A-FO	OTTURATORE COMPLETO	G-108-A-FO	BREACH BOLT COMPLETE	G-108-A-FO	BLOC DE CLASSE COMPLET
G-129	CARRELLO	G-129	ACTION BAR	G-129	BRAS DE COMMANDE
G-130-A	CARRELLO COMPLETO	G-130-A	ACTION BAR COMPLETE	G-130-A	BRAS DE COMMANDE COMPLET
H-001	LEVA ALIMENTAZIONE	H-001	MAGAZINE SHELL LATCH	H-001	LEVER D'ALIMENTATION
H-002	MOLLA LEVA ALIMENTAZIONE	H-002	MAGAZINE SHELL LATCH SPRING	H-002	RESSORT DE LEVER
H-007	PERNO PER LEVA (n° 2)	H-007	LATCH PIN (n° 2)	H-007	AXE DE LEVIER (n° 2)
H-008	MOLLA PER PERNO LEVA (n° 2)	H-008	LATCH PIN SPRING (n° 2)	H-008	RESSORT AXE DE LEVIER (n° 2)
H-019	MOLLA LEVA BLOCCA CARTUCCIA	H-019	CARTRIDGE RETAINING LATCH SPRING	H-019	ARRETOR DE MAGASIN
H-032-A	LEVA BLOCCA CARTUCCIA	H-032-A	CARTRIDGE RETAINING LATCH	H-032-A	RESSORT D'ARRETOR
H-033-A	LEVA SGANCIO CARRELLO	H-033-A	SLIDE UNHOOKING LEVER	H-033-A	ARRETOR DE CLASSE
H-034	MOLLA LEVA SGANCIO CARRELLO	H-034	SLIDE UNHOOKING LEVER SPRING	H-034	RESSORT D'ARRETOR DE CLASSE
H-121-IN01-ON	CARTESSA	H-121-IN01-ON	RECEIVER	H-121-IN01-ON	CARCASSE
H-600	GRANO BLOCCA VITE TIRAGGIO	H-600	STOPPING SCREW ON PIVOT BASIS	H-600	CONTRE VIS POUR BASE PIVOT
L-067	SPINA FISSAGGIO SUPPORTO ANTERIORE COPRICANNA (n° 2)	L-067	COOLING JACKET SUPPORT PINS (n° 2)	L-067	GOUILLES DE SUPPORT DE CHEMISE DE CANON (n° 2)
R-112	SPINA ARRESTO GUIDAMOLLA	R-112	BOLT SLIDE PIN	R-112	GOUILLE
V-260	GRANO BLOCCAGGIO MIRINO ANTERIORE	V-260	FRONT SIGHT RETAINING SCREW	V-260	VIS DE BLOCAGE DE VERROU
V-429	VITE FISSAGGIO BASE MIRA CARCASSA	V-429	PICATINNY RAIL LOCKING BASIS SCREWS	V-429	VIS POUR BASE DE VERROU DE RAIL PICATINNY
A-053	CALCIOLO 12mm	A-053	RECUL PAD 12mm	A-053	SABOT ANTI-RECUL 12mm
A-075	CALCIOLO HRA 27mm	A-075	HRA RECUL PAD 27mm	A-075	SABOT ANTI-RECUL HRA 27mm
F-149-A	REDUTTORE A 3 COLPI (2 + 1)	F-149-A	REDUCER TO 3 SHOTS (2 + 1)	F-149-A	REDUCTEUR A 3 COUPS (2 + 1)
F-029-A	REDUTTORE A 3 COLPI (2 + 1)	F-029-A	REDUCER TO 3 SHOTS (2 + 1)	F-029-A	REDUCTEUR A 3 COUPS (2 + 1)
F-141-A	REDUTTORE A 3 COLPI (2 + 1)	F-141-A	REDUCER TO 3 SHOTS (2 + 1)	F-141-A	REDUCTEUR A 3 COUPS (2 + 1)
F-030-A	REDUTTORE A 3 COLPI (2 + 1)	F-030-A	REDUCER TO 3 SHOTS (2 + 1)	F-030-A	REDUCTEUR A 3 COUPS (2 + 1)